

# SK 55 DGL 126

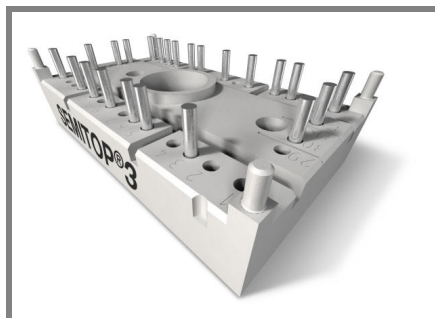

**SEMITOP<sup>®</sup> 3**

**3-phase bridge rectifier +  
brake chopper**

**SK 55 DGL 126**

Preliminary Data

## Features

- Compact design
- One screw mounting
- Heat transfer and isolation through direct copper bonded aluminum oxide ceramic (DCB)
- Trench IGBT technology
- CAL Technology FWD

## Typical Applications\*

- Rectifier

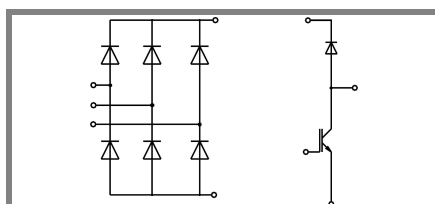

DGL

Absolute Maximum Ratings		$T_s = 25^\circ\text{C}$ , unless otherwise specified	
Symbol	Conditions	Values	Units
<b>IGBT - Chopper</b>			
$V_{CES}$		1200	V
$I_C$	$T_s = 25$ (80) $^\circ\text{C}$	40 (32)	A
$I_{CRM}$	$I_{CRM} = 2 \times I_{Cnom}$ , $t_p = 1$ ms	70	A
$V_{GES}$		$\pm 20$	V
$T_j$		-40 ... +150	$^\circ\text{C}$
<b>Diode - Chopper</b>			
$I_F$	$T_s = 25$ (80) $^\circ\text{C}$	45 (35)	A
$I_{FRM}$	$I_{FRM} = 2 \times I_{Fnom}$ , $t_p = 1$ ms	100	A
$T_j$		-40 ... +150	$^\circ\text{C}$
<b>Rectifier</b>			
$V_{RRM}$		1600	V
$I_D$	$T_s = 80$ $^\circ\text{C}$	55	A
$I_{FSM} / I_{TSM}$	$t_p = 10$ ms, sin $180^\circ$ , $T_j = 25$ $^\circ\text{C}$	370	A
$I_t^2$	$t_p = 10$ ms, sin $180^\circ$ , $T_j = 25$ $^\circ\text{C}$	685	$\text{A}^2\text{s}$
$T_j$		-40 ... +150	$^\circ\text{C}$
$T_{sol}$	Terminals, 10s	260	$^\circ\text{C}$
$T_{stg}$		-40 ... +125	$^\circ\text{C}$
$V_{isol}$	AC, 1 min. / 1s	2500 / 3000	V

Characteristics		$T_s = 25^\circ\text{C}$ , unless otherwise specified			
Symbol	Conditions	min.	typ.	max.	Units
<b>IGBT - Chopper</b>					
$V_{CEsat}$	$I_C = 35$ A, $T_j = ()$ $^\circ\text{C}$		1,7 (2)	2,1	V
$V_{GE(th)}$	$V_{GE} = V_{CE}$ , $I_C = 1,5$ mA	5	5,8	6,5	V
$V_{CE(TO)}$	$T_j = 25$ $^\circ\text{C}$ (125) $^\circ\text{C}$		1 (0,9)	1,2	V
$r_T$	$T_j = 25$ $^\circ\text{C}$ (125) $^\circ\text{C}$		20 (31)	26	m $\Omega$
$C_{ies}$	$V_{CE} = 25$ V, $V_{GE} = 0$ V, $f = 1$ MHz		2,4		nF
$C_{oes}$	$V_{CE} = 25$ V, $V_{GE} = 0$ V, $f = 1$ MHz		0,5		nF
$C_{res}$	$V_{CE} = 25$ V, $V_{GE} = 0$ V, $f = 1$ MHz		0,4		nF
$R_{th(j-s)}$	per IGBT			1,05	K/W
$t_{d(on)}$	under following conditions		85		ns
$t_r$	$V_{CC} = 600$ V, $V_{GE} = \pm 15$ V		30		ns
$t_{d(off)}$	$I_C = 30$ A, $T_j =$ $^\circ\text{C}$		430		ns
$t_f$	$R_{Gon} = R_{Goff} = 22$ $\Omega$		90		ns
$E_{on}$	inductive load		4,6		mJ
$E_{off}$			4,3		mJ
<b>Diode - Chopper</b>					
$V_F = V_{EC}$	$I_F = 45$ A, $T_j = ()$ $^\circ\text{C}$		1,5 (1,5)	1,77 (1,77)	V
$V_{(TO)}$	$T_j =$ $^\circ\text{C}$ (125) $^\circ\text{C}$		(0,92)		V
$r_T$	$T_j =$ $^\circ\text{C}$ (125) $^\circ\text{C}$		(13,4)		m $\Omega$
$R_{th(j-s)}$	per diode			1,2	K/W
$I_{RRM}$	under following conditions		30		A
$Q_{rr}$	$I_F = 50$ A, $V_R = 600$ V		10		$\mu\text{C}$
$E_{rr}$	$V_{GE} = 0$ V, $T_j =$ $^\circ\text{C}$				mJ
	$di_F/dt = 500$ A/ $\mu\text{s}$				
<b>Diode rectifier</b>					
$V_F$	$I_F = 25$ A, $T_j = ()$ $^\circ\text{C}$		-	1,25	V
$V_{(TO)}$	$T_j = 150$ $^\circ\text{C}$		0,8		V
$r_T$	$T_j = 150$ $^\circ\text{C}$		13		m $\Omega$
$R_{th(j-s)}$	per diode		2		K/W
<b>Temperatur sensor</b>					
$R_{ts}$	%, $T_r = ()$ $^\circ\text{C}$		( )		$\Omega$
<b>Mechanical data</b>					
w			30		g
$M_s$	Mounting torque			2,5	Nm

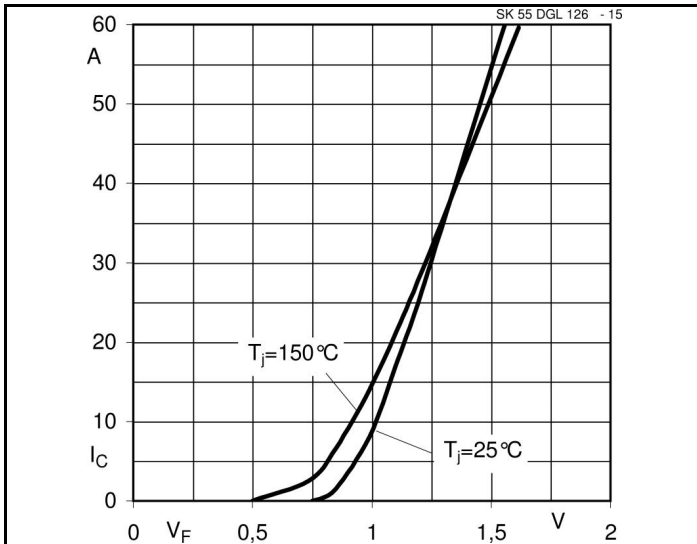

Fig.15 Typical input diode bridge forward characteristic

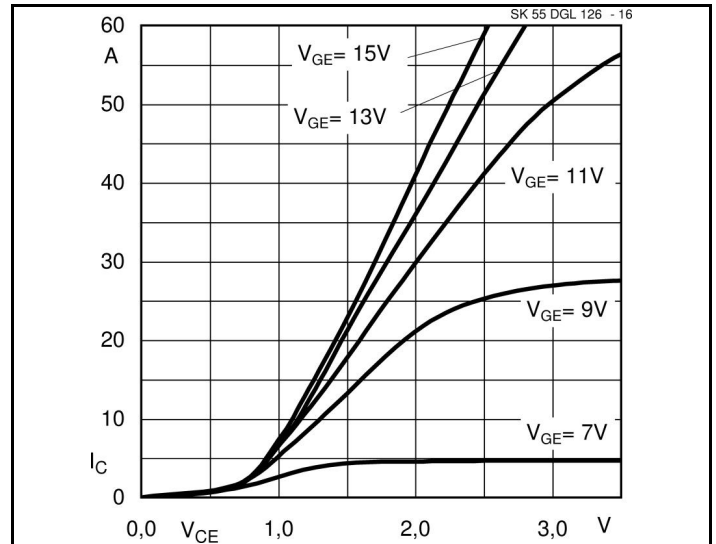

Fig.16 Typical IGBT output characteristic

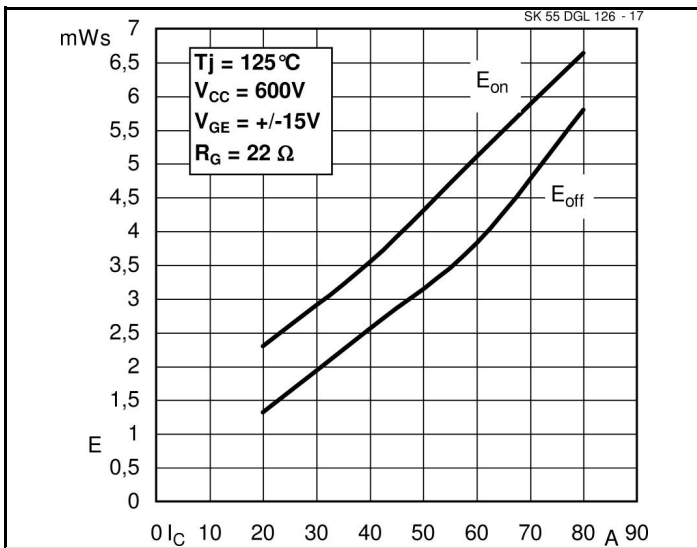

Fig.17 Turn-on/off energy=f(Ic)

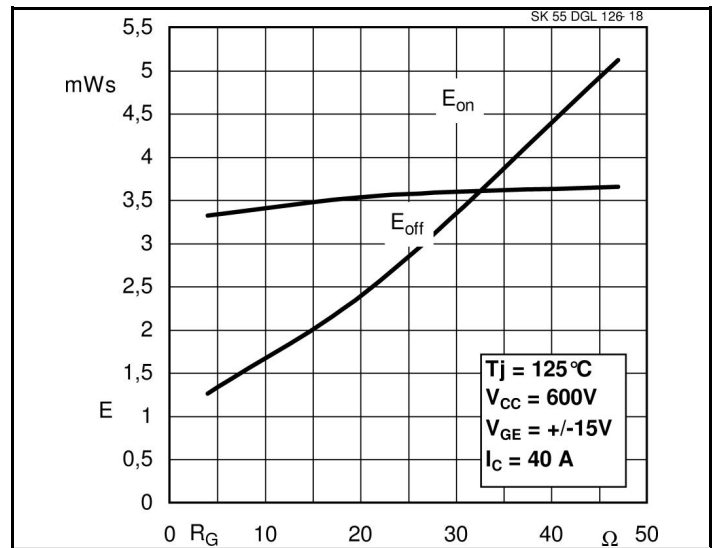

Fig.18 Turn-on/off energy=f(Rg)

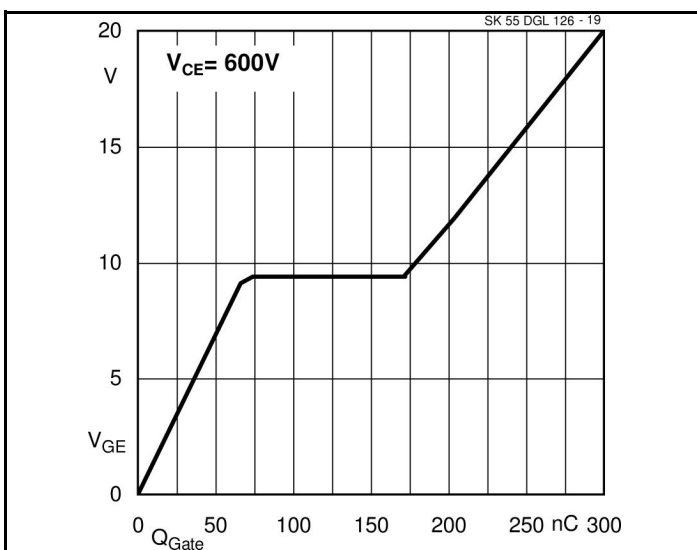
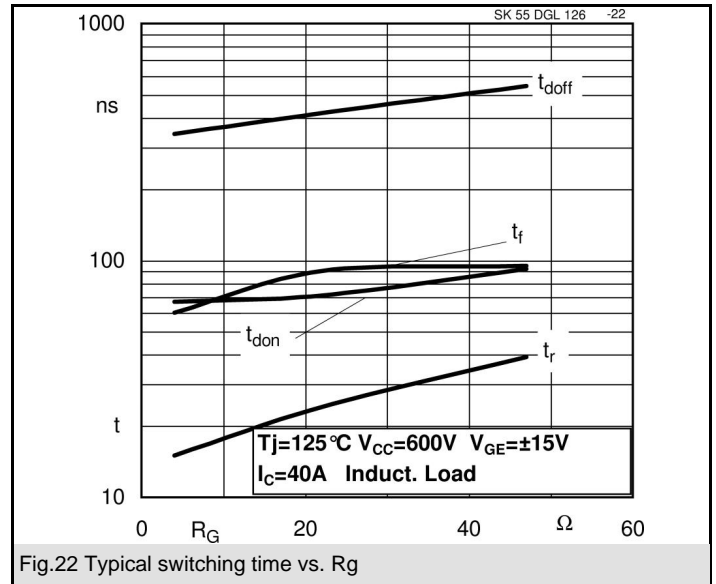
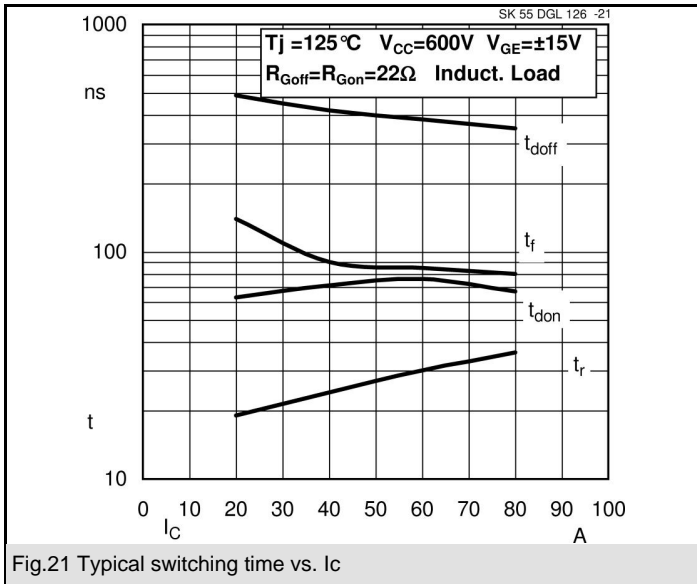
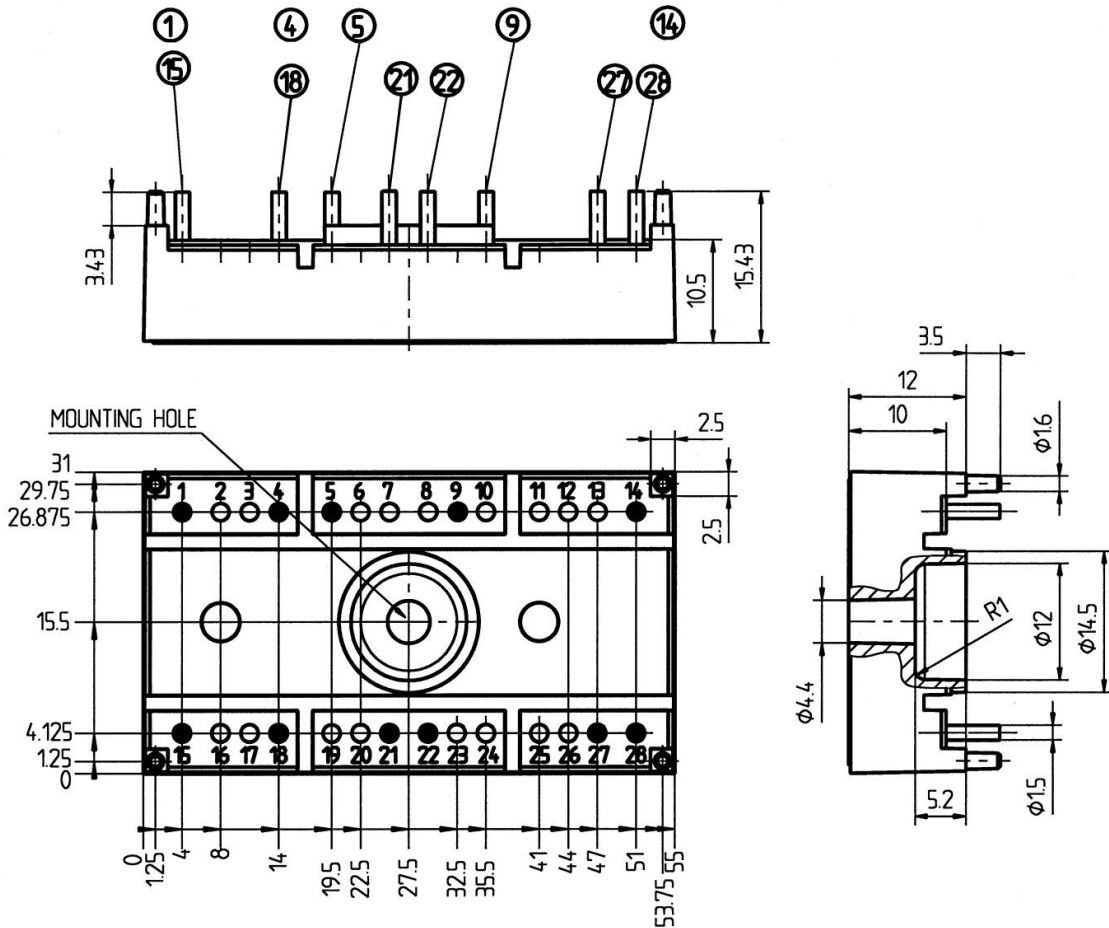
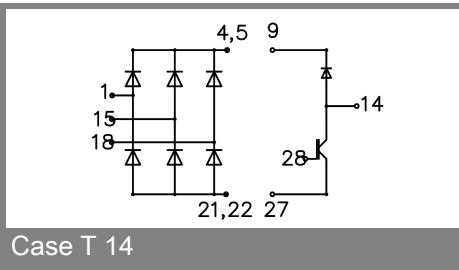

Fig.19 Typical gate charge characteristic





Case T 14 (Suggested hole diameter, in the PCB, for solder pins and plastic mounting pins: 2mm)



Case T 14

This is an electrostatic discharge sensitive device (ESDS), international standard IEC 60747-1, Chapter IX.

\* The specifications of our components may not be considered as an assurance of component characteristics. Components have to be tested for the respective application. Adjustments may be necessary. The use of SEMIKRON products in life support appliances and systems is subject to prior specification and written approval by SEMIKRON. We therefore strongly recommend prior consultation of our personal.